

# Application Information

## Buck-Boost Converter Evaluation Board with PIS3675



*Enhancing everyday life*



---

# Table of Contents

1. Introduction .....	2
1.1 Circuit Diagram .....	2
1.2 Specifications.....	2
1.3 Evaluation Board .....	2
1.4 Test Setup .....	3
2. Design Considerations.....	4
3. Test Results .....	4
3.1 Test Equipment.....	4
3.2 Test waveforms.....	5
3.3 Efficiency.....	6
4. Reference .....	7

# 1. Introduction

This document provides the features, operations, board setup procedure, and boost converter design parameters and basic information to designing with the boost converter design using the PIS3481 DC/DC controller and the MOSFET from Potens Semiconductor Corp [1].

## 1.1 Circuit Diagram

The PIS3675 is the PWM control IC for the buck-boost converter. Fig. 1 shows the power stage circuit, control and feedback circuit for the buck-boost converter. The main circuit is including power inductors(2uF, TMPF1508AV-2R0MN-ABD), input/output capacitors, MOSFETs (PDC8976BX and PDC39G8BX) and PIS3675[2][3]. For this evaluation board, the input voltage is 9V~15V, the output voltage is 12V, and the maximum output current is 25A and the switching frequency is ~240 kHz.

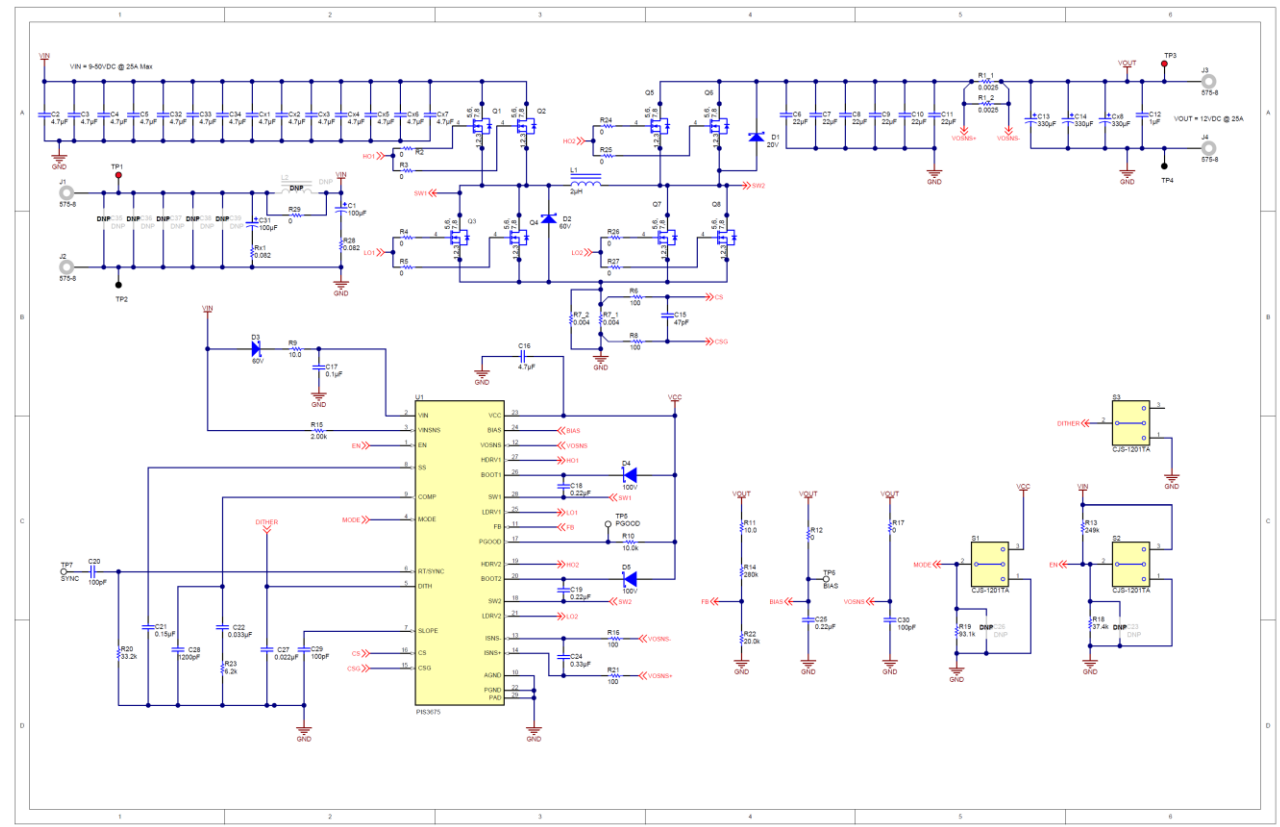

Fig. 1 The circuit diagram of the buck boost evaluation board

## 1.2 Specifications

Table 1 is the main parameters of the evaluation board.

## 1.3 Evaluation Board

Figure 2 shows the top side of the DK3-23 evaluation board.

Table 1. The evaluation board specifications

Parameter	Value
Input voltage	9~15Vdc
Output voltage	12Vdc
Maximum output current	25A
Maximum output power	300W

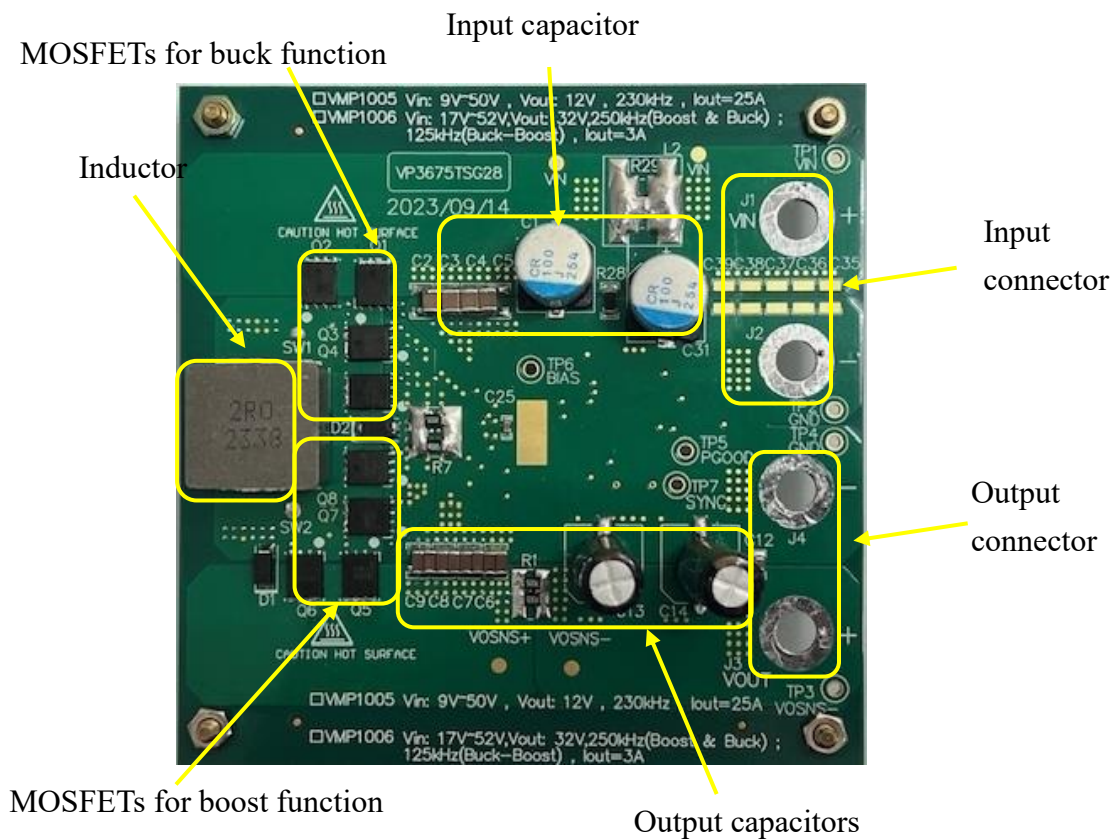

Fig. 2 the top side of the boost converter evaluation board

#### 1.4 Test Setup

The evaluation board test setup is as follows:

- Step 1. Input connector connects to DC source (Voltage setting:9~15Vdc)
- Step 2. Output connector connects to DC load
- Step 3. Power on the DC source (9 Vdc for boost function, 12 for buck boost function or 15Vdc for buck function)
- Step 4. Adjust output loading (0A~25A)

## 2. Design Considerations

From the volt-second balance principle, the duty cycle of input and output voltage relation for boost convert design is derived as below:

$$V_{OUT} = \frac{V_{IN}}{1-D} \quad (1)$$

where  $V_{OUT}$  is output voltage,  $V_{IN}$  is input voltage and  $D$  is duty cycle. Let the converter operates in continuous current mode for the low ripple current requirement. The duty cycle for input voltage is 9V and output voltage is 12V is derived as:

$$12V = \frac{9V}{1-D} \Rightarrow D = 0.25 \quad (2)$$

The switching frequency is set as ~240kHz. The frequency adjust resistor  $R_{20}$  can be derived as:

$$R_T = \frac{\frac{1}{f_S} - 200ns}{37pF} = \frac{\frac{1}{240k} - 200ns}{37pF} = 107k\Omega \quad (3)$$

where  $f_S$  is switching frequency. From the volt-second balance principle, the duty cycle of input and output voltage relation for buck convert design is derived as below:

$$D = \frac{V_{OUT}}{V_{IN}} \quad (3)$$

Let the converter operates in continuous current mode for the low ripple current requirement. The duty cycle for input voltage is 15V and output voltage is 12V is derived as:

$$D = \frac{12V}{15V} \Rightarrow D = 0.25 \quad (4)$$

## 3. Test Results

The test equipment and experimental results of the buck boost evaluation board applying PWM control IC PIS3675 are shown as following subsection.

### 3.1 Test Equipment

The table 2 shows the test equipment.

Table 2. List of the test equipment

Test equipment	Model
DC Power Supply	ITECH IT6874A
Electronic load	ITECH IT8700
Power meter	YOKOGAWA WT310
Oscilloscope	Angilent DSO-X 6004A

### 3.2 Test waveforms

Fig. 3 (a)(b) shows the steady state waveforms of  $V_{IN} = 9V$  at minimum and maximum load for boost function and the switching frequency is  $\sim 240kHz$ . Channel 1 is  $V_{gs}$  of low side MOSFET of boost function and Channel 2 is  $V_{ds}$  of low side MOSFET of boost function. Fig. 4 (a)(b) shows the steady state waveforms of  $V_{IN} = 12V$  at minimum and maximum load for buck function. Channel 1 is  $V_{gs}$  of low side MOSFET of boost function and Channel 2 is  $V_{ds}$  of low side MOSFET of buck function. Fig. 4 (c)(d) shows the steady state waveforms of  $V_{IN} = 12V$  at minimum and maximum load for boost function. Channel 1 is  $V_{gs}$  of low side MOSFET of boost function and Channel 2 is  $V_{ds}$  of low side MOSFET of boost function. Fig. 5 (a)(b) shows the steady state waveforms of  $V_{IN} = 15V$  at minimum and maximum load and the switching frequency is  $\sim 240kHz$ . Channel 1 is  $V_{gs}$  of low side MOSFET of buck function and Channel 2 is  $V_{ds}$  of low side MOSFET of buck function.

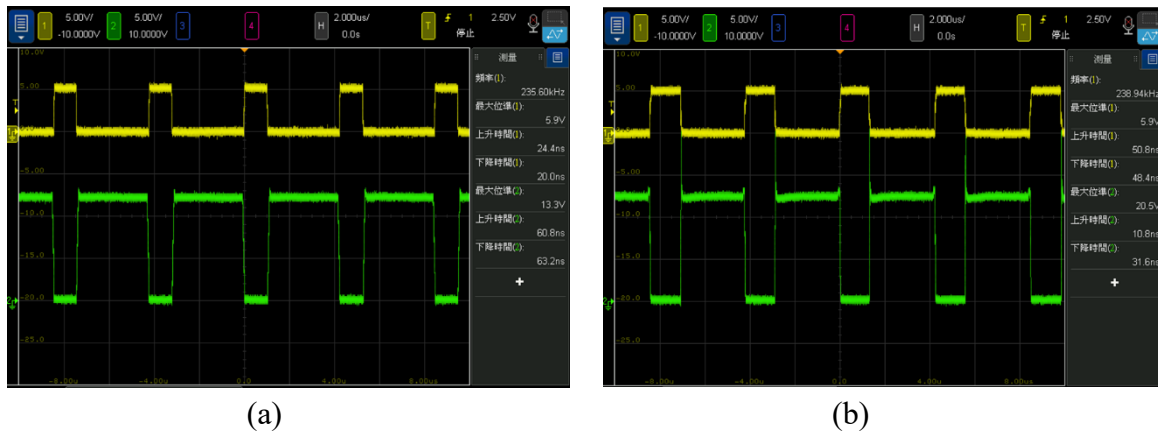
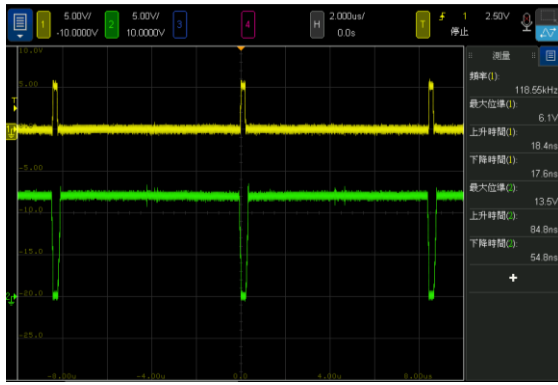
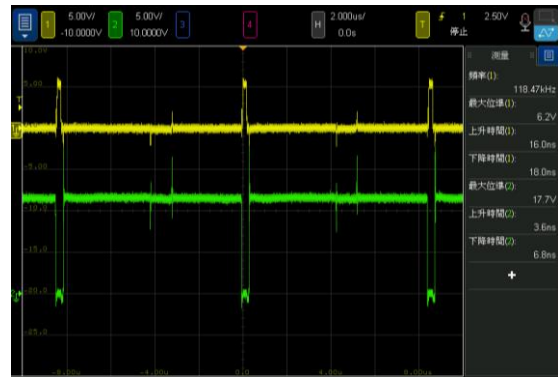

Fig. 3(a) shows the waveforms of  $V_{IN} = 9V$  at minimum load for boost function (b) shows the waveforms of  $V_{IN} = 9V$  at maximum load for boost function.



(a)



(b)

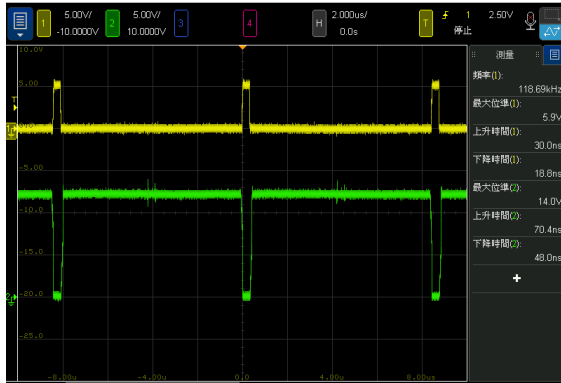

(c)

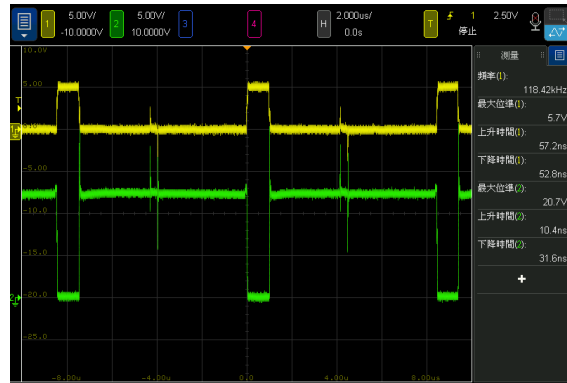

(d)

Fig. 4(a) shows the waveforms of  $V_{IN} = 12V$  at minimum load for buck function (b) shows the waveforms of  $V_{IN} = 12V$  at maximum load for buck function (c) shows the waveforms of  $V_{IN} = 12V$  at minimum load for boost function (d) shows the waveforms of  $V_{IN} = 12V$  at maximum load for boost function.

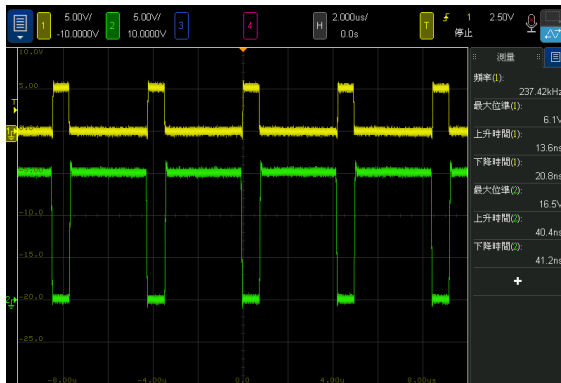

(a)

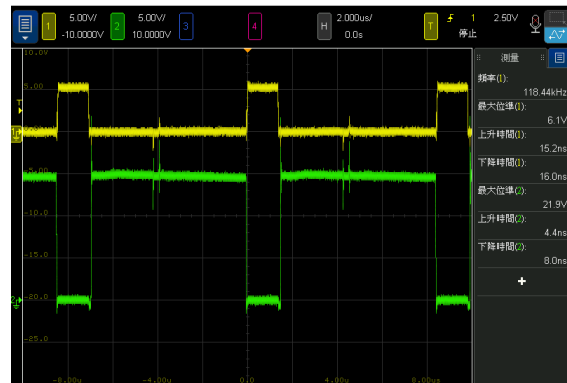

(b)

Fig. 5(a) shows the waveforms of  $V_{IN} = 15V$  at minimum load for buck function (b) shows the waveforms of  $V_{IN} = 15V$  at maximum load for buck function.

### 3.3 Efficiency

The efficiency results are shown in Fig. 6.

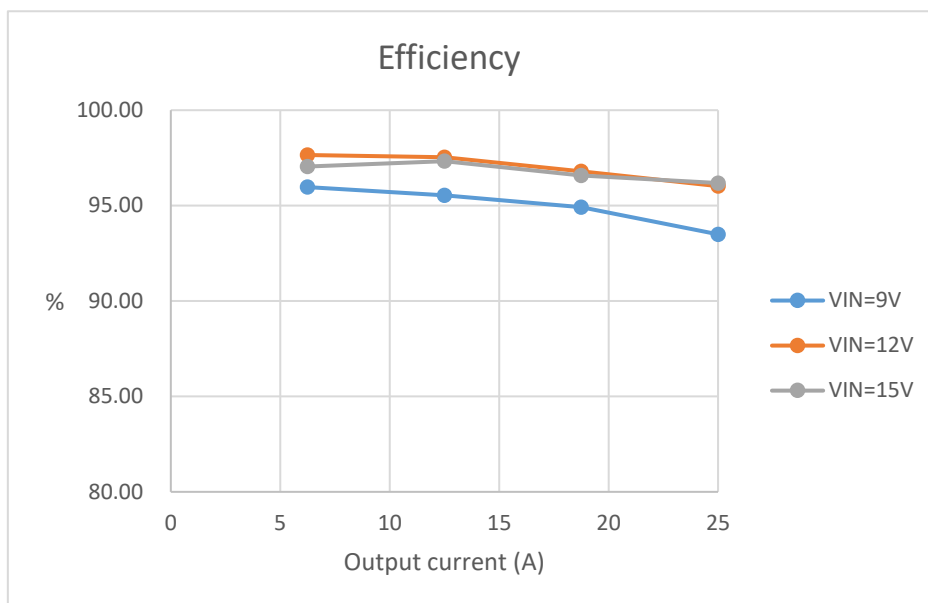

Fig. 6 the efficiency of buck boost converter

## 4. Reference

- [1] Potens Semiconductor, “High Efficiency DC/DC Controller,” PIS3675 datasheet.
- [2] Potens Semiconductor, “80V N-channel MOSFET,” PDC8976BX datasheet.  
<https://www.potens-semi.com/upload/product/PDC8976BX.pdf>.
- [3] Potens Semiconductor, “65V N-channel MOSFET,” PDC39G8BX datasheet.  
<https://www.potens-semi.com/upload/product/PDC39G8BX.pdf>.
- [4] TAI-TECH Advanced Electronics, “Hi-current Power Inductor,” TMPF1508AV-2R0MN-ABD datasheet.  
<https://www.tai-tech.com.tw/product?mcls=1551832443&cls=1562812531&cls2=1562812531&cls3=1562828822&pid=1585204001>